

RoHS

REV.	ECN NO.	LOCATIONS	DESCRIPTION	DATE	DESIGN
A0			原始版本(INITIAL EDITION)		

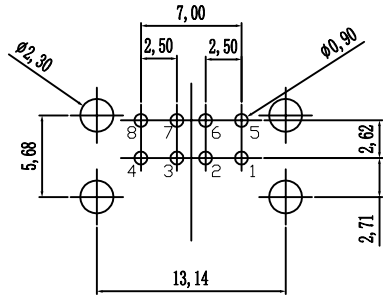

RECOMMEND P. C. B . LAYOUT  
(T=1.60 ± 0.05)

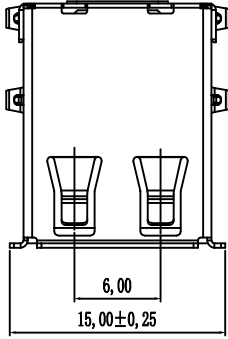
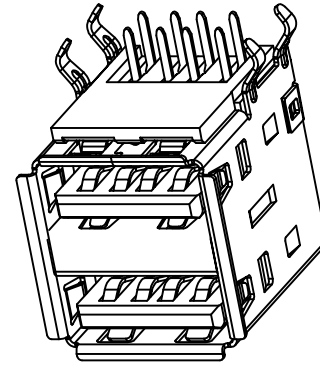

Material:  
 1.Housing:a:PBT Black  
 2.Contact:C2680R-H  
 3.Shell:SPCC  
 4.Middle Spring: SUS201-H

Specification:  
 1.Current: 1.5A  
 2.Voltage: 30V RMS  
 3.Withstanding Voltage: 500V AC  
 4.Contact Resistance: 30 mΩ max.  
 5.Insulation Resistance: 1000 MΩ min.  
 6.Temperature Range: -25°C to +85°C  
 7.Mating And unmating Force:  
 7.1 Mating Force:35N Max.  
 7.2 Unmating Force:10N Min. Initial

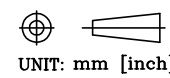
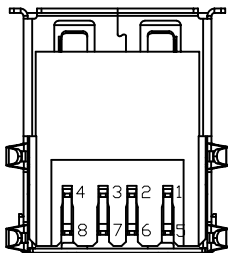
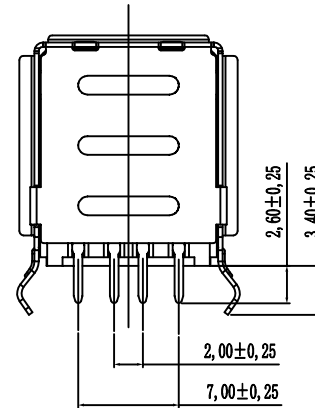
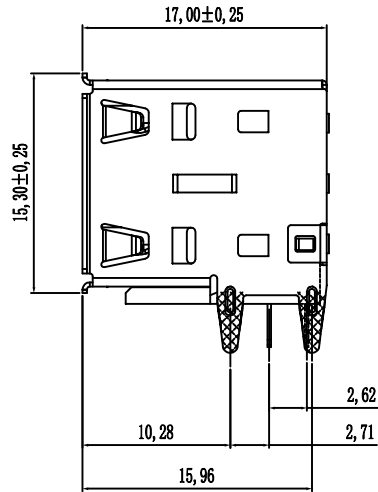
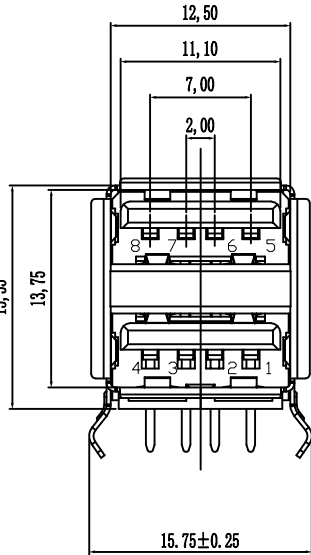

TOLERANCE:  
 X.X ±0.35  
 X.XX ±0.25  
 X.XXX ±0.15  
 Angle ±3.0°

SCALE:1:1 SIZE:A4



深圳市盈创利电子有限公司  
 Shenzhen Ying Chuang Li Electronics co., LTD.

DESIGN: 黄宝樑

CHECKED:

APPROVED:

PART NAME:  
 双层USB2.0 A-TYPE 黑色 铁壳 有翻边  
 弯脚 针长2.6

PART NO. 5U02-016B

DRAW NO.

SHEET NO. 1 OF 1