

RoHS

REV.	ECN NO.	LOCATIONS	DESCRIPTION	DATE	DESIGN
AO			原始版本(INITIAL EDITION)		

NOTES:
 ELECTRICAL:
 1. VOLTAGE RATING: 125V AC.
 2. CURRENT RATING: 1.5A.
 3. CONTACT RESISTANCE: 30 mΩ MAX.
 4. INSULATION RESISTANCE: 500 MΩ MIN @ 500V DC.
 5. DIELECTRIC STRENGTH: 1000V AC 50Hz or 60Hz, 1MIN.
 MECHANICAL:
 1. INSERT MATERIAL: PBT BLACK UL94V-0
 2. SHELL: Copper alloy nickl plating
 3. CONTACT MATERIAL: DIAMETER 0.46mm C51000 (QSn4-0.3) PHOSPHOR BRONZE GOLD PLATING OVER NICKEL.
 4. LED: SPCC
 4. MATING/UNMATING FORCE: 2.2KG.F MAX.
 5. RETENTION STRENGTH: 7.7KG.F MIN BETWEEN JACK AND PLUG.
 6. OPERATING LIFE: 750 CYCLES MIN.
 ENVIRONMENTAL:
 1. STORAGE: -40°C ~ +85°C RELATIVE HUMIDITY<70%.
 2. OPERATION: -40°C ~ +85°C.

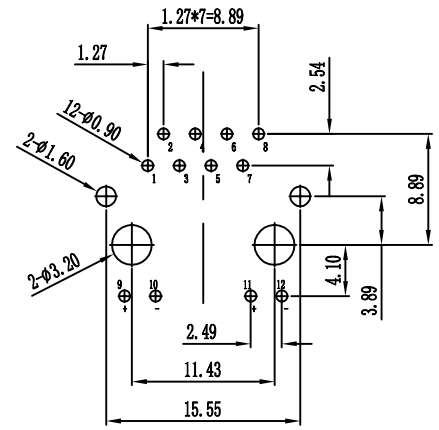
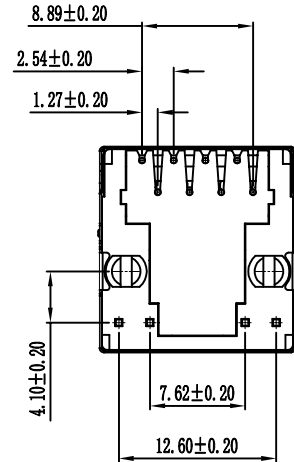
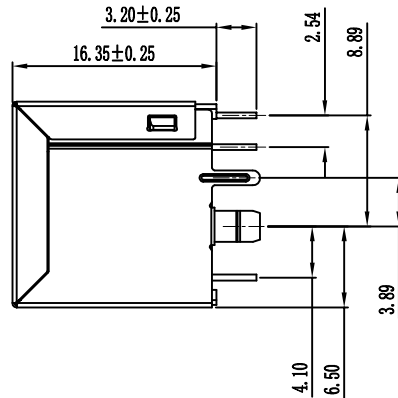
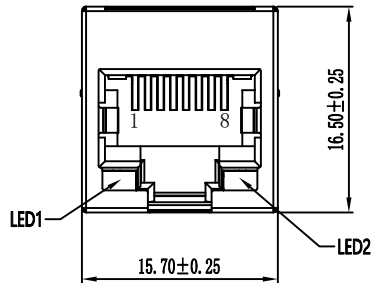
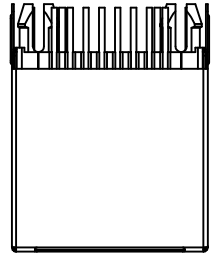

RECOMMENDED P.C.B LAYOUT
 TOP VIEW (COMPONENT SIDE)

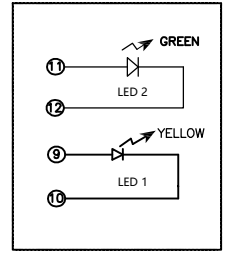
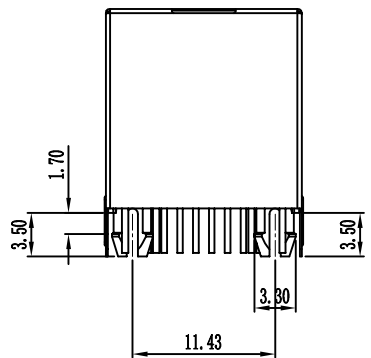

RJ45 Pin definition:

Pin位	Name	Description
1	TX+	Tranceive Data+
2	TX-	Tranceive Data-
3	RX+	Receive Data+
4	N/C	Not connected
5	N/C	Not connected
6	RX-	Receive Data-
7	N/C	Not connected
8	N/C	Not connected

 UNIT: mm [inch] TOLERANCE: X.X ±0.35 X.XX ±0.25 X.XXX ±0.15 Angle ±3.0° SCALE:1:1 SIZE:A4	 深圳市盈创利电子有限公司 Shenzhen Ying Chuang Li Electronics co., LTD.	
	DESIGN:	PART NAME:
	CHECKED:	RJ45 5224 包壳 左黄右绿 后脚3.89
	APPROVED:	PART NO. 5A25-223A
	DRAW NO.	
	SHEET NO.	1 OF 1

RoHS

REV.	ECN NO.	LOCATIONS	DESCRIPTION	DATE	DESIGN
AO			原始版本(INITIAL EDITION)		

吸塑上盖

吸塑下盖

两侧打订书订

ROHS
X

每盘左下角贴ROHS标签
以及QC编号

2叠

产品方向

18盘/叠

100PCS/盘

透明胶纸

标签

3600PCS/箱

备注:

1. 纸箱材质:K=A;规格400X285X345MM
2. 每盘包装数量: 100PCS/盘
3. 每箱包装数量: 100X36=3600PCS/箱
4. 将装好产品的18个吸塑盒整齐叠放在一起, 每盘左下角贴ROHS标签以及QC编号;两侧打订书订共两叠3600PCS,放入纸箱中,用透明胶纸封好纸箱。

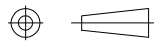
 UNIT: mm [inch]
TOLERANCE: X.X ±0.35 X.XX ±0.25 X.XXX ±0.15 Angle ±3.0°
SCALE:1:1 SIZE:A4

 深圳市盈创利电子有限公司 Shenzhen Ying Chuang Li Electronics co., LTD.		DESIGN:		PART NAME:	
		CHECKED:		RJ45 5224 外壳带灯 后脚3.89	
APPROVED:		PART NO.	5A25-233A		
		DRAW NO.			
		SHEET NO.	1 OF 1		