

RoHS

REV.	ECN NO.	LOCATIONS	DESCRIPTION	DATE	DESIGN
A0			原始版本(INITIAL EDITION)		

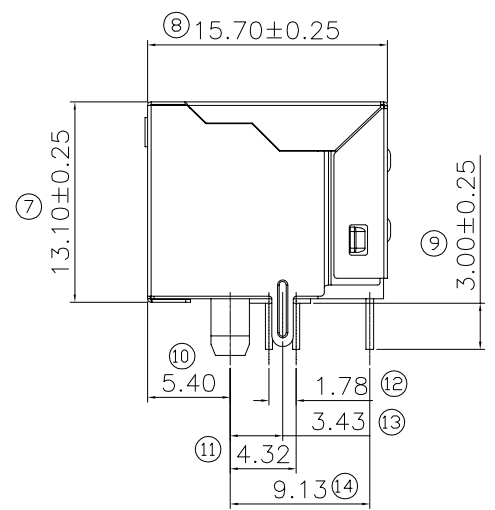
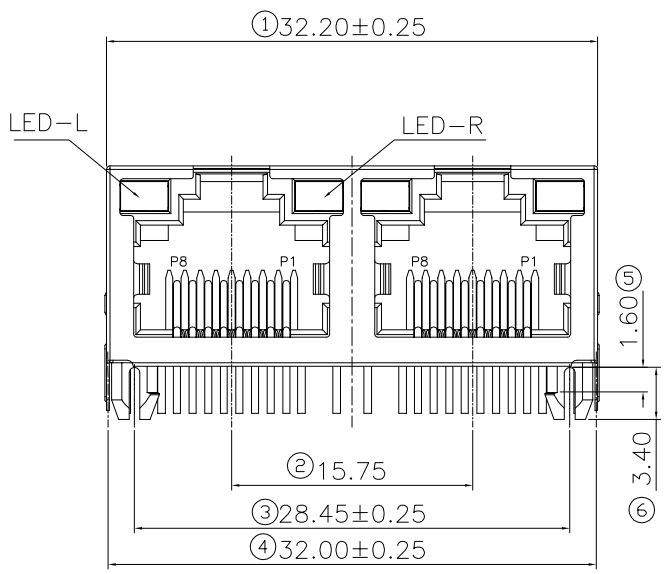

SPECIFICATION NOTES:

ELECTRICAL:

- VOLTAGE RATING:125 VAC RMS
- CURRENT RATING:1.5AMP
- CONTACT RESISTANCE:30mΩ MAX
- INSULATION RESISTANCE:1000MIN AT 500V DC
- DIELECTRIC STRENGTH:1000 VAC 50Hz 1MINUTE

MECHANICAL:

- SHELL:Copper Alloy PLATING NICKEL
- HOUSING:PA46 UL94V-0 BLACK
- CONTACT MATERIAL:DIAMETER 0.46MM PHOSPHOR BRONZE
- OPERATING LIFE:750 CYCLES MIN.
- MATING FORCE:22N MAX.

ENVIRONMENTAL:

- STORAGE:-40℃ TO +85℃
- OPERATION:-40℃ TO +85℃

RJ45 Pin definition:

Pin位	Name	Description
1	TX+	Tranceive Data+
2	TX-	Tranceive Data-
3	RX+	Receive Data+
4	N/C	Not connected
5	N/C	Not connected
6	RX-	Receive Data-
7	N/C	Not connected
8	N/C	Not connected

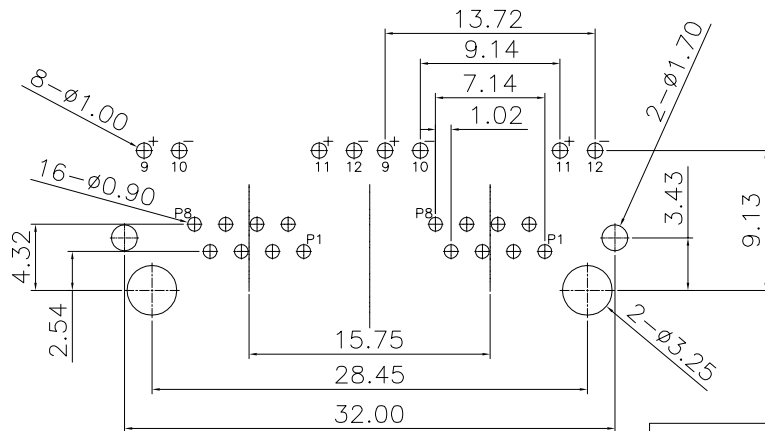
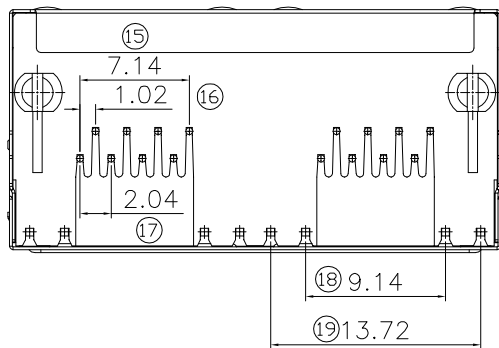

RECOMMENDED P.C.B LAYOUT  
TOP VIEW (COMPONENT SIDE)

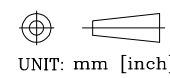
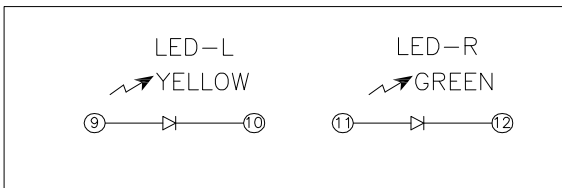
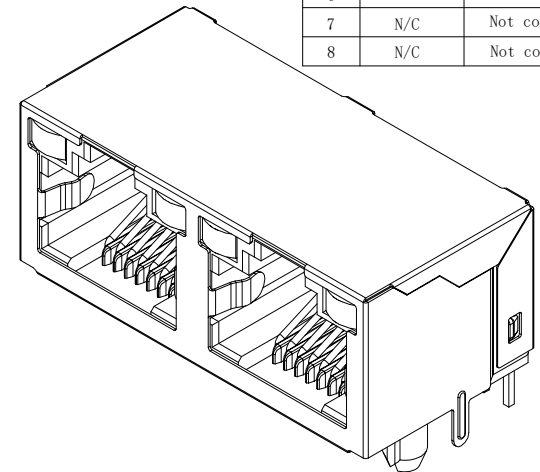

TOLERANCE:  
 X.X ±0.35  
 X.XX ±0.25  
 X.XXX ±0.15  
 Angle ±3.0°

SCALE:1:1 SIZE:A4

**深圳市盈创利电子有限公司**  
 Shenzhen Ying Chuang Li Electronics co., LTD.

DESIGN:  
 CHECKED:  
 APPROVED:

PART NAME:  
 RJ45 5JA 1X2 90度 DIP 带屏蔽 有灯无弹  
 PART NO. 5A17-071C  
 DRAW NO.  
 SHEET NO. 1 OF 1

RoHS

REV.	ECN NO.	LOCATIONS	DESCRIPTION	DATE	DESIGN
A0			原始版本(INITIAL EDITION)		

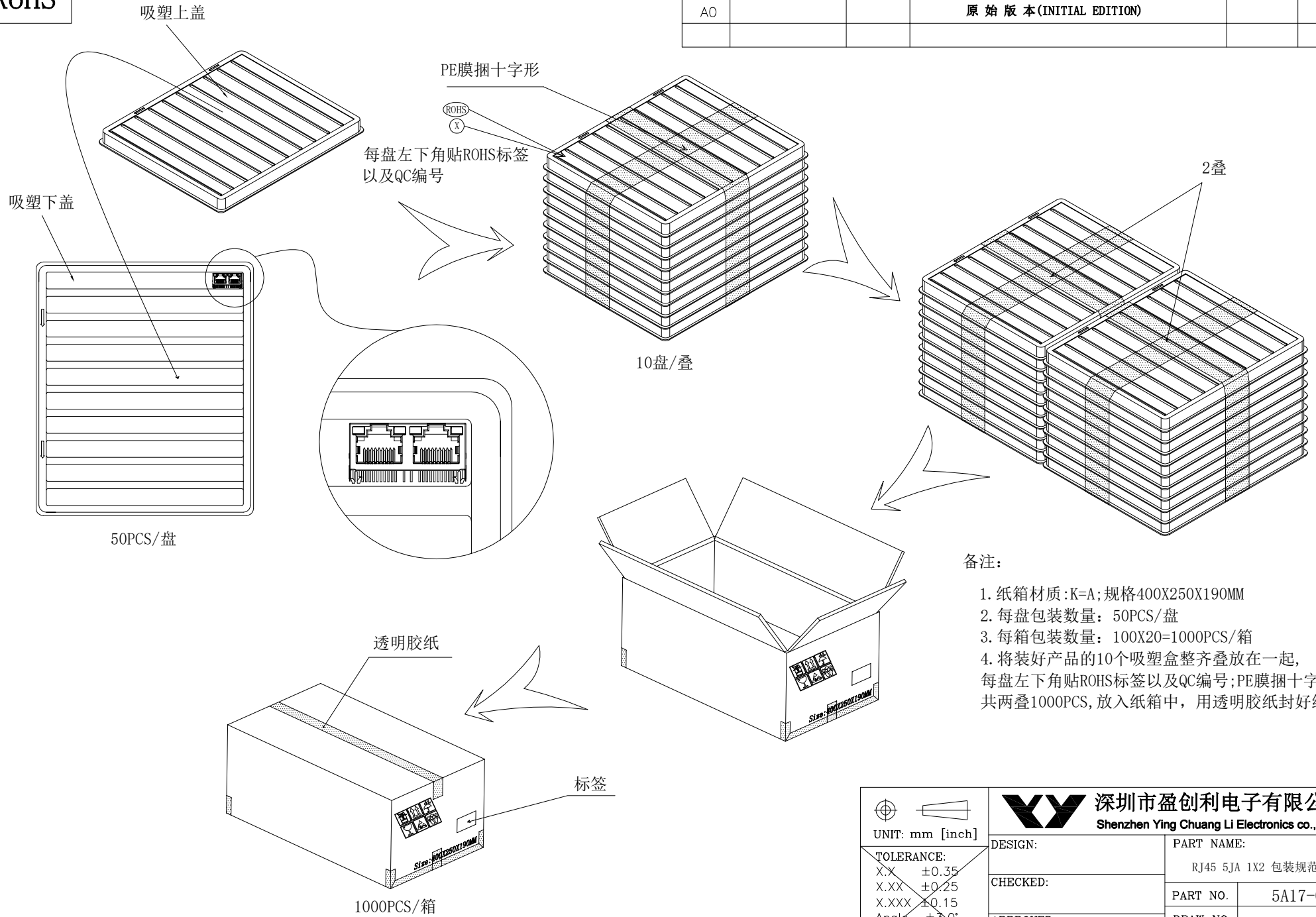

备注:

1. 纸箱材质:K=A;规格400X250X190MM
2. 每盘包装数量: 50PCS/盘
3. 每箱包装数量: 100X20=1000PCS/箱
4. 将装好产品的10个吸塑盒整齐叠放在一起, 每盘左下角贴ROHS标签以及QC编号;PE膜捆十字形共两叠1000PCS,放入纸箱中,用透明胶纸封好纸箱。

 UNIT: mm [inch]	<b>深圳市盈创利电子有限公司</b> Shenzhen Ying Chuang Li Electronics co., LTD.	
	DESIGN:	PART NAME:
	CHECKED:	RJ45 5JA 1X2 包装规范
	APPROVED:	PART NO. 5A17-071C
TOLERANCE: X.X ±0.35 X.XX ±0.25 X.XXX ±0.15 Angle ±3.0°	SCALE:1:1	SIZE:A4
SHEET NO. 1 OF 1		